

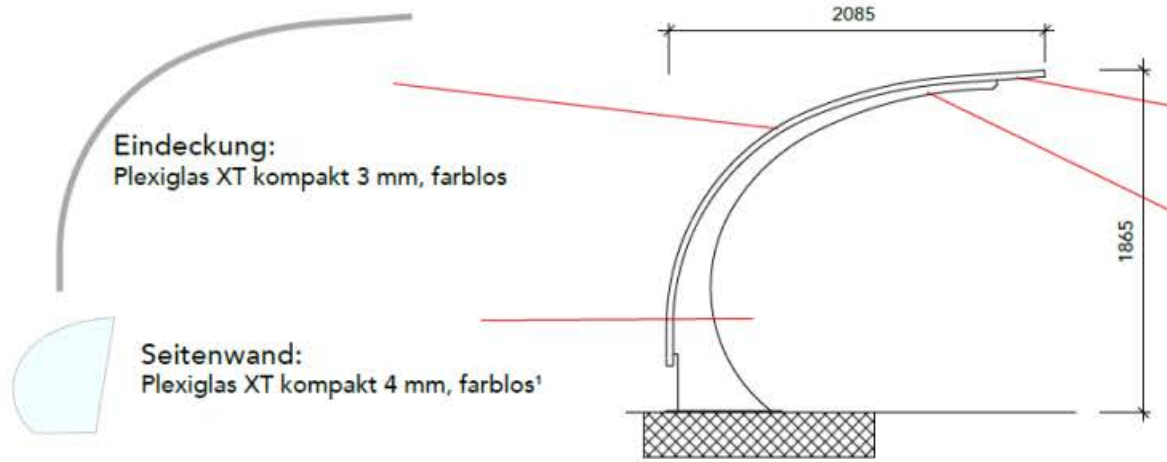

LUGANINO



Oberkonstruktion:
Stranggepresste Aluminiumprofile mit dem  System[®], farblos eloxiert²



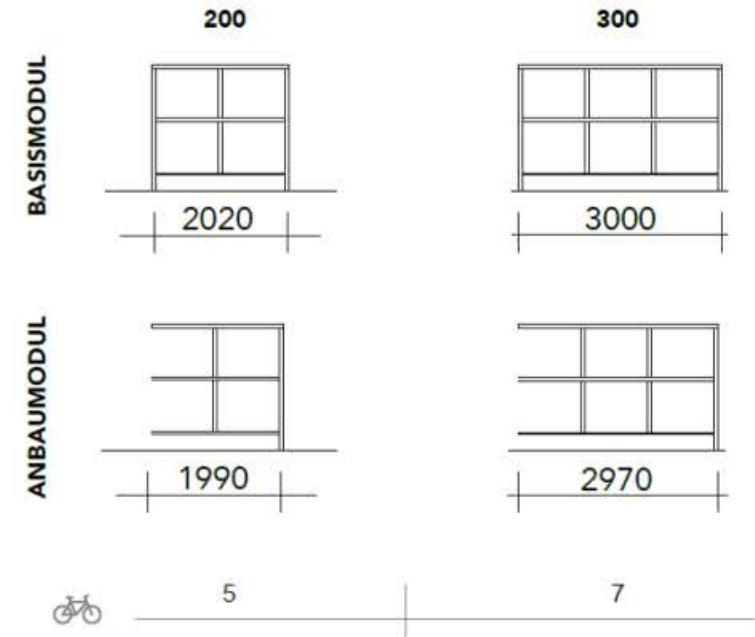

Tragkonstruktion:
Sichelförmige aus verzinktem Stahl



Installation auf fertigem Sockel mit Bodenbefestigung





- 20 
- 11 
- 23-24 
- 26 • 27 



¹ Auf Anfrage ohne Aufpreis für Plexiglas 4 mm in opal weiss, hellgrau oder dunkelgrau 

² Auf Anfrage ohne Aufpreis auch in Perlgrim anthrazitgrau erhältlich 