

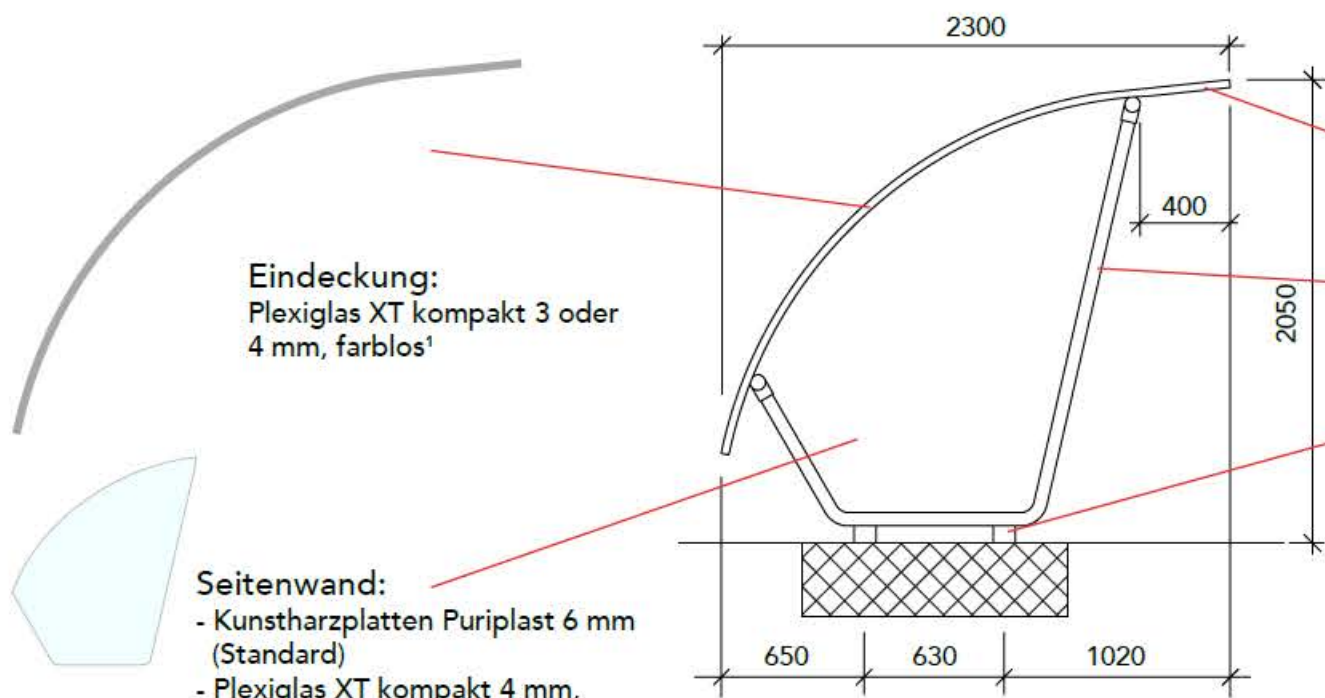

TUBO





Eindeckung:
Plexiglas XT kompakt 3 oder 4 mm, farblos¹

Seitenwand:
- Kunstharzplatten Puriplast 6 mm (Standard)
- Plexiglas XT kompakt 4 mm, farblos¹

Oberkonstruktion:
Stranggepresste Aluminiumprofile mit dem  System®, farblos eloxiert

Tragkonstruktion:
Verzinkte Stahlrundrohre

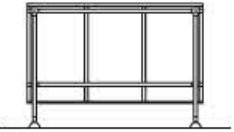
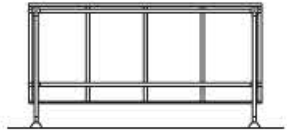
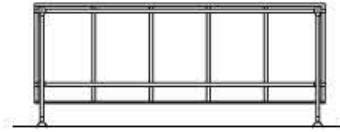
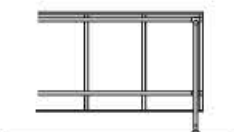
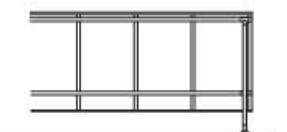
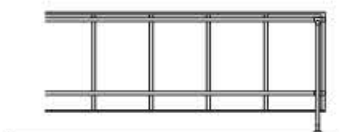
Fussplatten zur Bodenbefestigung

	300	400	500
BASISMODUL	 3000	 3980	 4960
ANBAUMODUL	 2970	 3950	 4930
	7	9	12
	3	4	5



23-24



26 • 27



¹ Auf Anfrage ohne Aufpreis für Plexiglas 4 mm in opal weiss, hellgrau oder dunkelgrau
• 3 mm → Schneelast SK 0,9 kN/m² — • 4 mm → Schneelast SK 1,5 kN/m² CE